









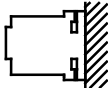
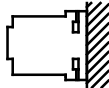
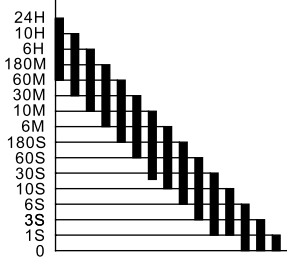
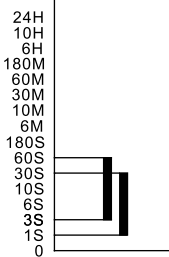

tend 限時繼電器 TIMER

型式 TYPE		TTN	TSN
名稱 NAME		限時繼電器 IC TIMER	馬達啟動專用型 STAR-DELTA TIMER
外觀 APPEARANCE			
安裝 MOUNTING	露出型(-N) SURFACE(-N)		
時間範圍 TIMING RANGE			
操作電壓 OPERATING VOLTAGE		AC 100/110V DC 12/24V 200/220V 50/60Hz	AC 100/110V DC 12/24V 200/220V 50/60Hz
指示燈 INDICATOR		ON-UP兩只指示燈 ON-UP TWO INDICATOR LAMP	計時中指示 TIME OPERATING
輸出 接點 O/P CONTACT	限時1C TIME-LIMIT 1C	5A	5A
	瞬時 INSTANTANEOUS	3A Ia	5A
壽命 LIFE	機械 MECHANICAL	五百萬次以上 5×10^6 times	五百萬次以上 5×10^6 times
	電氣 ELECTRICAL	十萬次以上 10^5 times	十萬次以上 10^5 times
精確度 ACCURACY	重複 REPEAT	±1%以下 ±1%max.	±1%以下 ±1%max.
	設定 SETTING	±10%以下 ±10%max.	±10%以下 ±10%max.
	電壓 VOLTAGE	±1%以下 ±1%max.	±1%以下 ±1%max.
	溫度 TEMPERATURE	±2%以下 ±2%max.	±2%以下 ±2%max.
復歸時間 RESET TIME		0.1秒以下 0.1 Sec. max.	0.2秒以下 0.2 Sec. max.
消耗功率 CONSUMED POWER		2VA	2VA
重量 WEIGHT		230g	250g

tend 限時繼電器 TIMER

型式 TYPE		TT3			TF3
名稱 NAME		限時繼電器 IC TIMER		限時繼電器 IC TIMER	閃爍繼電器 FLICKER RELAY
外觀 APPEARANCE					
安裝 MOUNTING	露出型(-N) SURFACE(-N)				
	埋入型(-Y) FLASH(-Y)			與TY-40配合 WITH TY-40	
時間範圍 TIMING RANGE					
操作電壓 OPERATING VOLTAGE		AC 100/110V DC 12/24V 200/220V 50/60Hz			AC 100/110V DC 12/24V 200/220V 50/60Hz
指示燈 INDICATOR		ON-UP兩只指示燈 ON-UP TWO INDICATOR LAMP			動作前指示 BEFORE CONTACT TRANSFER
輸出 接點 O/P CONTACT	種類 MODEL	TT3	TT3-1	TT3-2	
	限時1C TIME-LIMIT 1C	5A	5A		5A
	限時2C TIME-LIMIT 2C			5A	
	瞬時 INSTANTANEOUS	5A			
壽命 LIFE	機械 MECHANICAL	五百萬次以上 5×10^6 times			五百萬次以上 5×10^6 times
	電氣 ELECTRICAL	十萬次以上 10^5 times			十萬次以上 10^5 times
精確度 ACCURACY	重複 REPEAT	$\pm 1\%$ 以下 $\pm 1\%$ max.			$\pm 1\%$ 以下 $\pm 1\%$ max.
	設定 SETTING	$\pm 10\%$ 以下 $\pm 10\%$ max.			$\pm 10\%$ 以下 $\pm 10\%$ max.
	電壓 VOLTAGE	$\pm 1\%$ 以下 $\pm 1\%$ max.			$\pm 1\%$ 以下 $\pm 1\%$ max.
	溫度 TEMPERATURE	$\pm 2\%$ 以下 $\pm 2\%$ max.			$\pm 2\%$ 以下 $\pm 2\%$ max.
復歸時間 RESET TIME		0.1秒以下 0.1 Sec. max.			0.2秒以下 0.2 Sec. max.
消耗功率 CONSUMED POWER		2VA			2VA
重量 WEIGHT		160g			140g

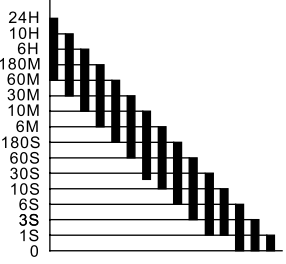
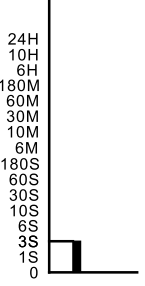
外型尺寸圖 DIMENSIONS(mm)

TTN.TSN

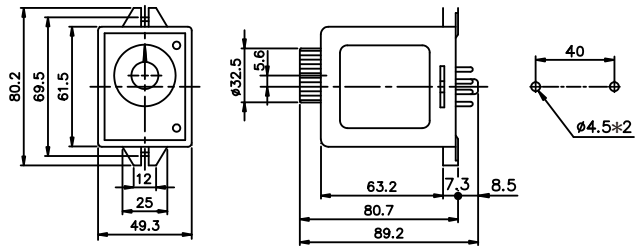

TT3.TF3

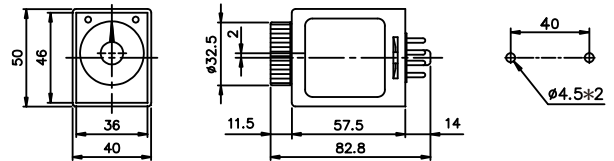

TT3與TY-40配合 TT3 WITH TY-40

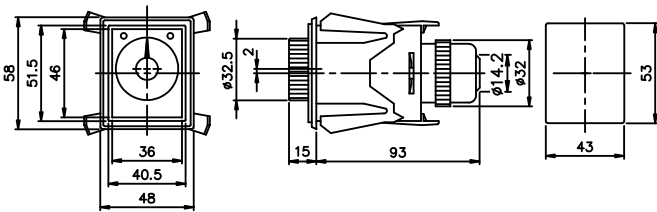

配線圖

CONNECTION DIAGRAMS

TTN.TT3

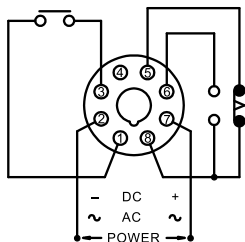

動作時間圖

TIMING CHART

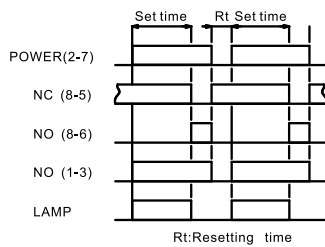

配線圖

CONNECTION DIAGRAMS

TSN

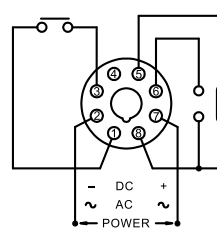

動作時間圖

TIMING CHART

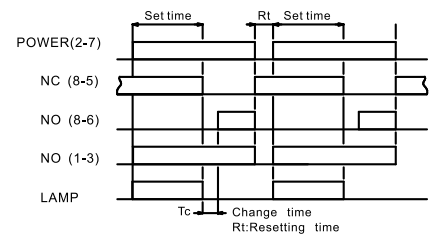

TT3-1

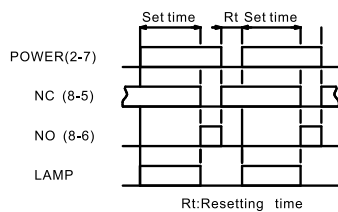
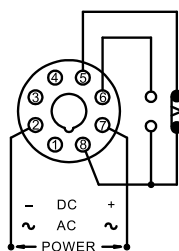

TF3

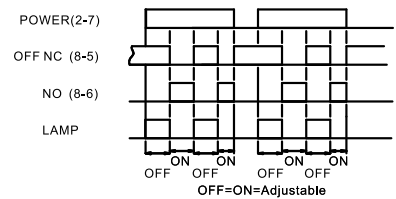
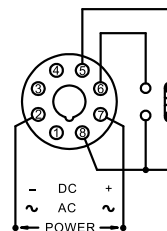

TT3-2

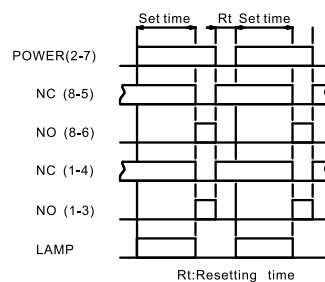
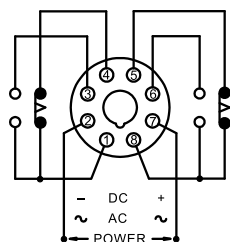

PF-083N

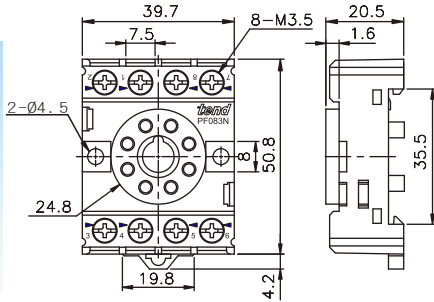

PF-113N

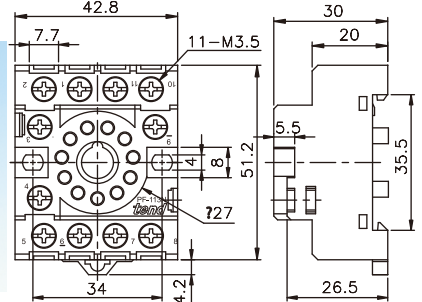

PYF-08N

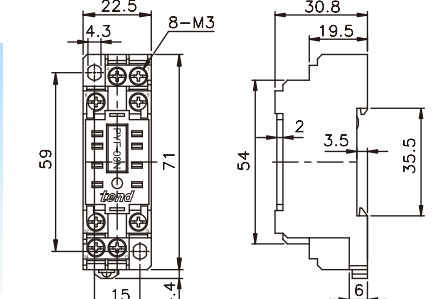

PYF-14N

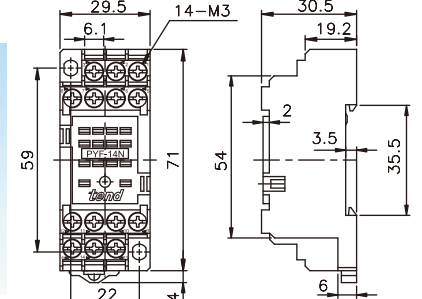

PTF-08N

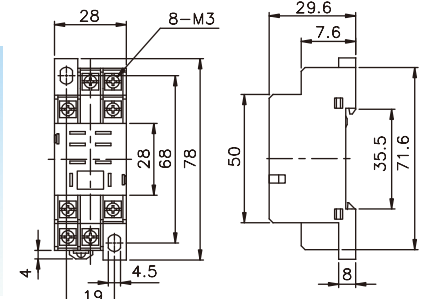

PTF-14N

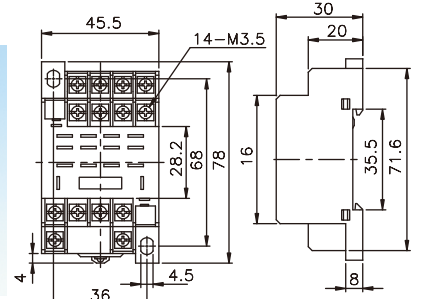

PF-085A

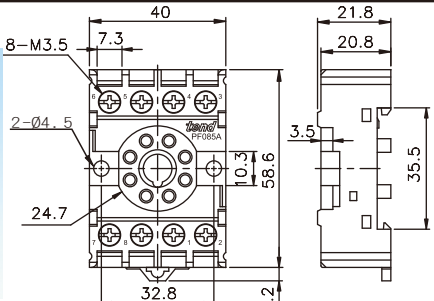

8PF-R

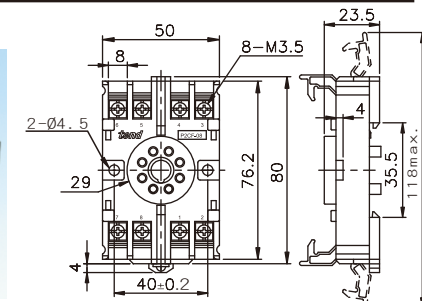
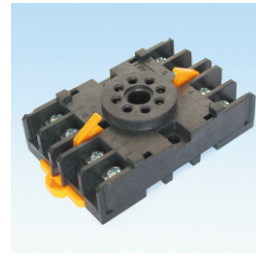

P2CF-08

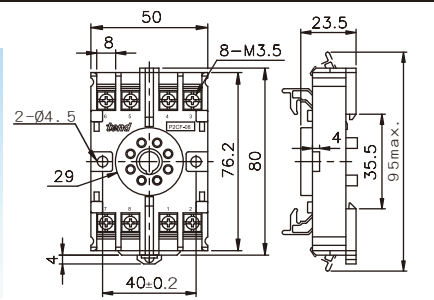

P2CF-11

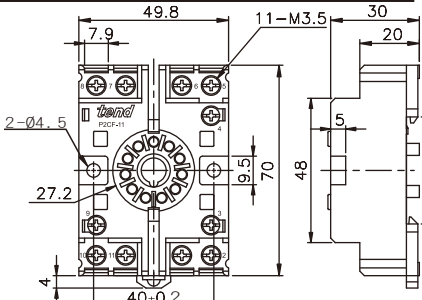

P3G-08

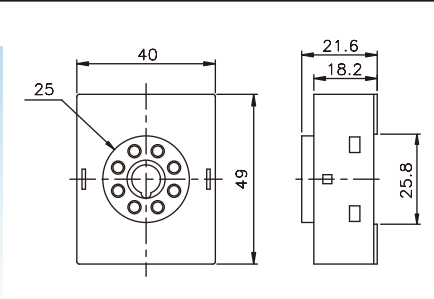
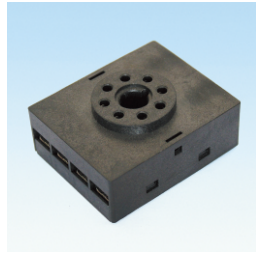

US-08

